

INSTRUCTIONS

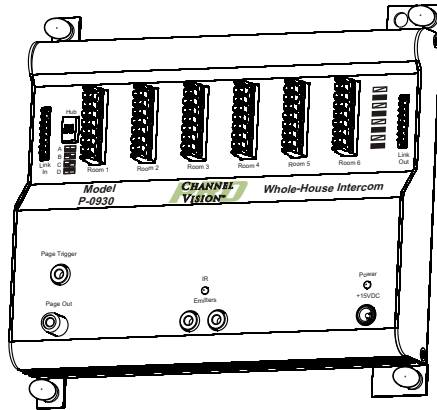
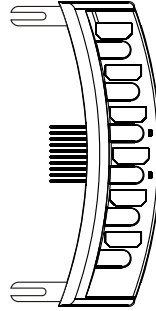
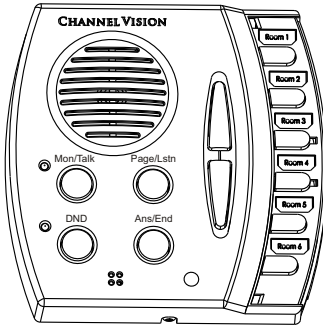

ST-2000
ST-2100
P-0930
CAT5 Whole-House Intercom System

● CHANNEL VISION™
PRO

©2008 CHANNEL VISION TECHNOLOGY

The Channel Vision CAT5 Whole-House Intercom System consists of two basic components: P-0930 Intercom Hub and ST-2000 Intercom Station. The system can be expanded through the use of additional hubs and intercom stations. The ST-2000 provides direct call buttons for 6 rooms. The ST-2100 Intercom Station Expander can be used to add more direct call buttons in larger systems . If a front door intercom station is required, Channel Vision's popular IU-xxxxC or DP-xxxxC can be easily integrated as one of the intercom stations, and when used with the ST-C51DS Door Strike Relay module, the system can activate an electronic door strike or gate opener.

Features:

- Direct communication from room to room
- Expandable up to 24 stations
- Baby Monitor and Do Not Disturb modes
- Built-in IR repeating
- Intercom calls can be activated with an IR remote control
- Whole-house paging
- Two distinct door chimes
- Answer function calls the last station that paged

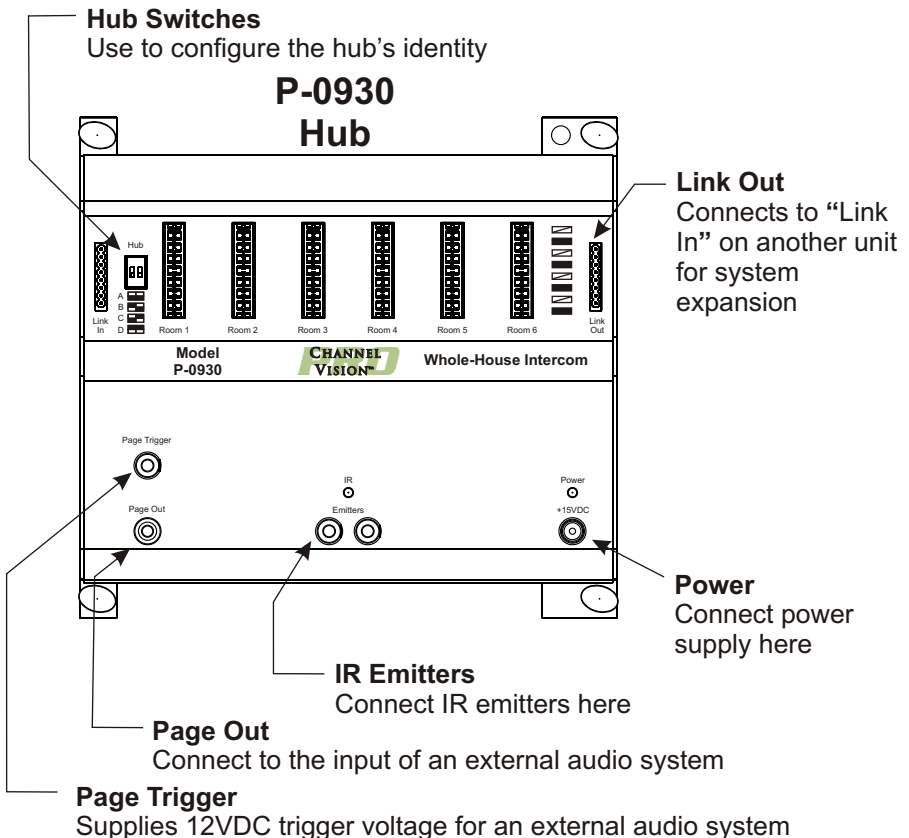

ST-2000 Intercom Station

ST-2100 Station Expander

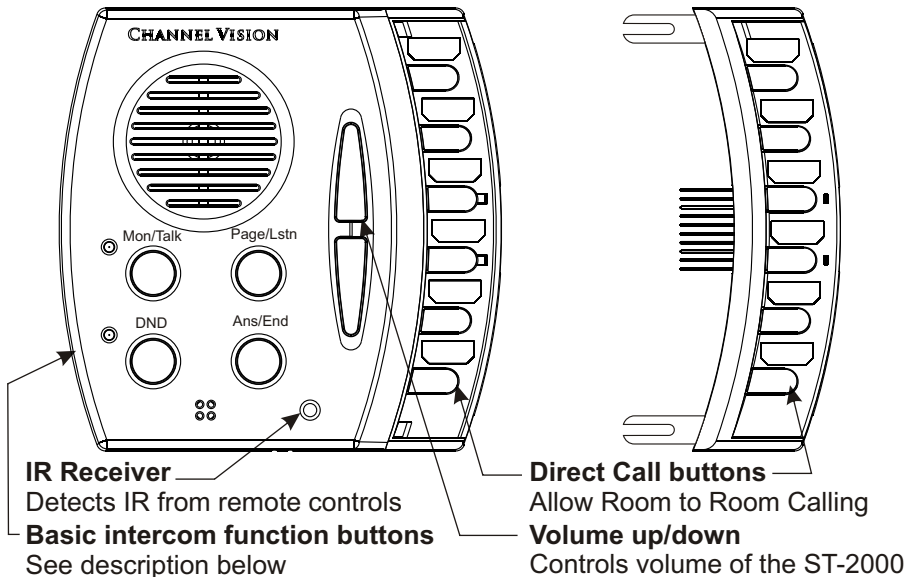

How it works:

Every intercom zone (or room) will have at least one ST-2000 which will provide direct call access to the first 6 rooms. For larger systems (up to 24 zones), model ST-2100 can be added to allow direct call access to more zones. Note: larger systems will also require the addition of more P-0930 intercom hubs.

Functions:

Page/Lstn - Press "Page/Lstn" to call all other stations in the system. Note: Pressing "Ans/End" will mute an incoming page.

DND - Press once to enter the 'ring only' mode (LED turns Orange). In this mode other stations can ring you, but you must press "Ans/End" to accept the call. Press the button a second time and the LED turns Red, now other stations will hear a busy tone when they call your station.

Ans/End - Press this button to: 1) Call back the station that just paged, 2) Answer a door station call (press & hold for 3 seconds to activate the ST-C51DS strike relay), 3) Answer a direct call when in the 'ring only' mode, 4) Press this button again to end the call.

Mon/Talk - 1) Press and hold this button for 2 seconds (LED turns Red) to allow your station to be monitored from other stations, 2) Press and release (LED turns Green) to listen to another station that is in monitor mode. Note: Rooms being monitored will not hear any pages. Pressing "Ans/End" will release a station from monitor mode.

Push-To-Talk Mode: Room to Room (for noisy environments) - This system normally operates in a 'hands-free' mode so the person responding to a direct intercom call can simply speak and the ST-2000 automatically detects when the person has finished speaking. However, if there is significant background noise, the ST-2000 will not distinguish between voice and background noise. In this case, press and hold the "Mon/Talk" button (LED turns Orange) this will override the automatic voice switching and allow the person holding the "Mon/Talk" button to be heard in the other room. After the call, the system will revert back to 'hands-free' mode. Note: the push-to-talk mode only occurs when a call has been initiated between two locations. If a call is not already in progress, pressing and holding the "Mon/Talk" button will engage the monitor mode as described above.

Push-To-Talk Mode: Room to Door - Hold down the "Mon/Talk" button while speaking to a door. The LED turns Orange.

Push-To-Talk Mode: Door to Room - Hold down the "Page/Lstn" button to hear the person at the door station speaking to you. The LED turns Green.

Basic Application

In a basic 6 room system, any ST-2000 station is capable of calling another station directly, simply by pressing any of the 6 direct call buttons. The top direct call button corresponds to room 1, the second button corresponds to room 2 and so on.

The intercom stations can be activated from across the room by using the A0503 IR remote control, allowing you to make an intercom call while sitting in your favorite chair. The IR receiver that is integrated with the ST-2000 can also be used to send IR signals back to components in a different room, such as DVD players or media servers.

The Page Out feature on the P-0930 enables intercom pages to be broadcast to an external audio system. Many audio systems that provide a page input for this purpose also require a trigger voltage to activate the paging function. The P-0930 provides a 3.5mm Page Trigger jack that supplies 12VDC for the duration of the intercom page.

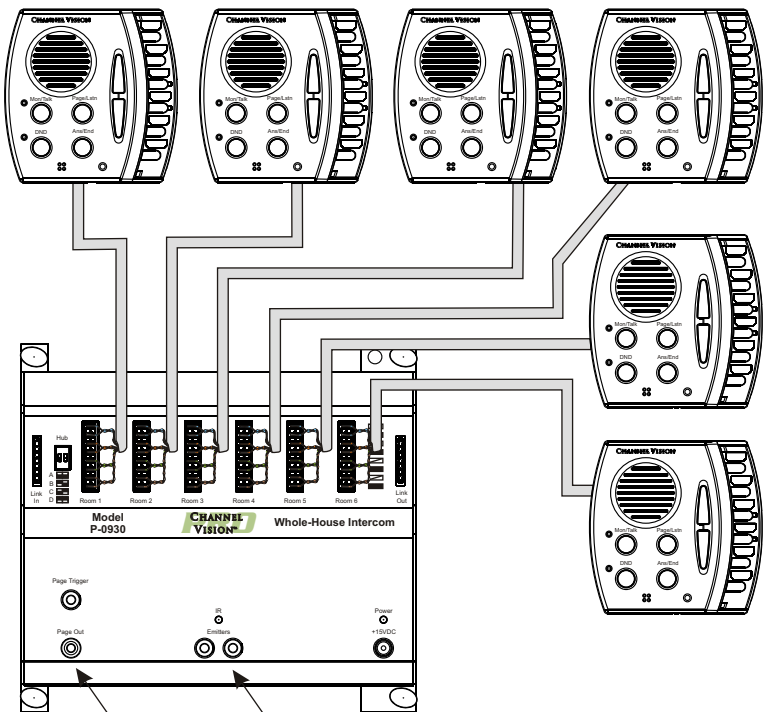

Connect IR emitters here to control other devices

Connect to the input of an external audio system

Expanding the System

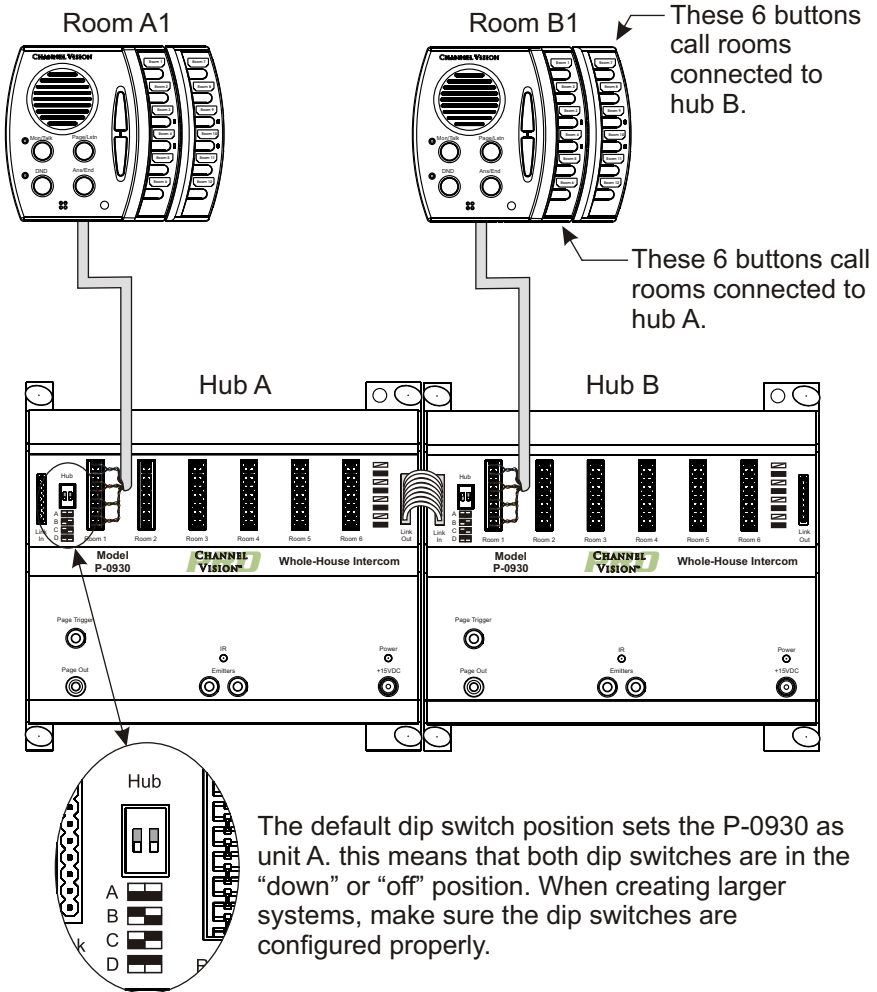

When expanding the system to more than 6 rooms, connect the Link Out from P-0930 to the Link In of another P-0930 using the small ribbon cable provided. As many as 4 P-0930 intercom hubs can be linked together to create a 24-room system. The dip switches located near the Link In connector allow each hub to be identified by a letter, such as A, B, C, or D. Each station can accept up to 3 ST-2100 station expanders (see page 3). The 6 room call buttons on the ST-2000 are always associated with hub A. The 6 room call buttons on the first ST-2100 are associated with hub B, the 6 room call buttons on the second ST-2100 are associated with hub C, and the 6 room call buttons on the third ST-2100 are associated with hub D.

Installing the ST-2000

1. Install a standard double gang low-voltage ring

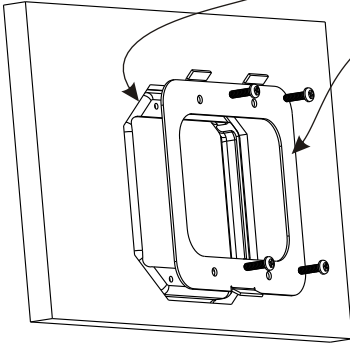

2. Attach the ST-2000 mounting bracket to the low-voltage ring

Note: these tabs are on top

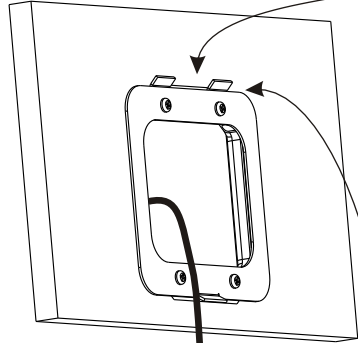

3. Pull the CAT5 wire through the opening and terminate it to the back side of the ST-2000

Note: these hooks will align with the tabs at the top of the bracket

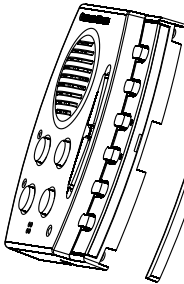
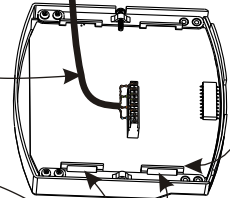

4. Slide the end cover into place from the back side of the ST-2000

Note: When adding ST-2100 Station Expanders move the end cover to the last ST-2100

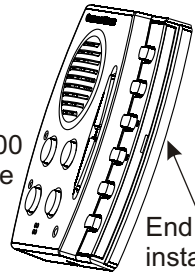

End cover installed

5. Hang from top

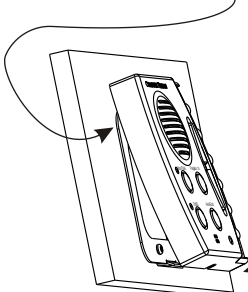

and rotate down

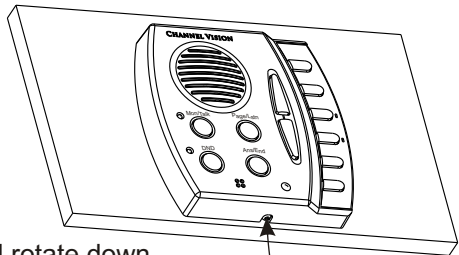

6. Tighten screw to lock in place

Customizing Room Labels

The room labels on the intercom stations can be customized to help the user remember which buttons correspond to which room. For example, instead of having labels that say: Room 1, Room 2, Room 3, etc. you can label those rooms as: Kitchen, Bedroom, Bathroom, etc. To create paper labels of the appropriate size, you can download a label template from www.channelvision.com that will allow you to create custom labels and print them on standard 8.5" x 11" paper. Then use scissors to cut along the template guidelines. To install the custom labels, follow the simple steps below:

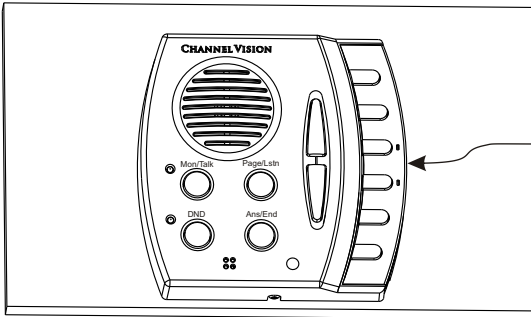

Push here to release the label cover

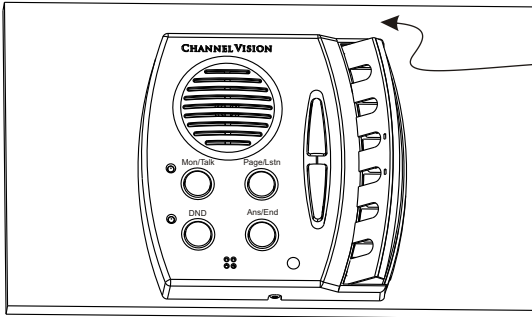

The label cover should now swing off

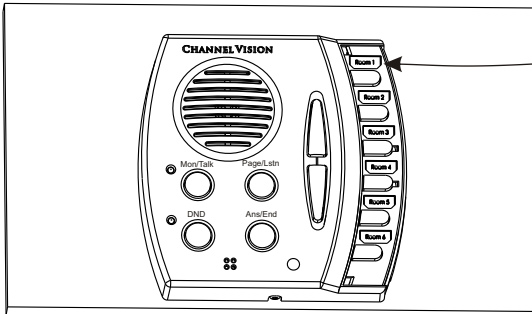

Replace the labels
Use tweezers if needed
Replace the label cover

Installing the ST-2100 Station Expander

The intercom system can be expanded to more than six stations by adding the ST-2100 to the ST-2000. Although several ST-2100 expanders can be attached to each ST-2000, everything still attaches to a standard double gang low-voltage ring. The ST-2100 is very slim so it attaches to the side of the ST-2000 and sits on the surface of the wall.

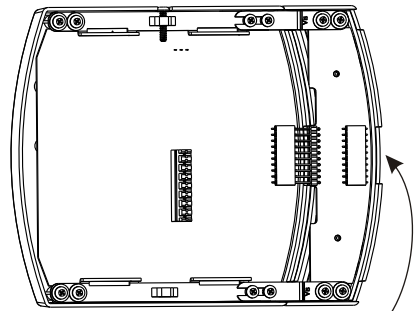
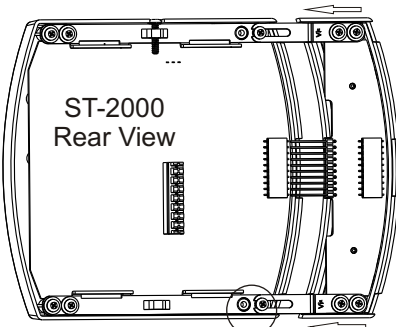
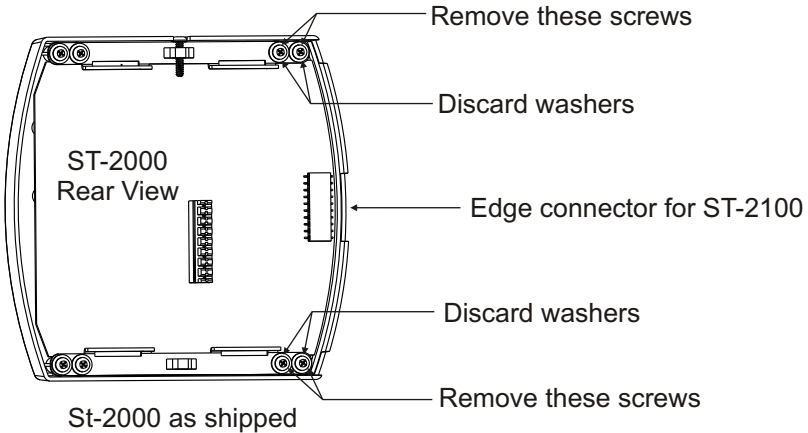

IMPORTANT: Hole in this bottom bracket must fit over plastic boss. (Metal must not sit on top of plastic. Or button functions may be affected.)

Using the Page Out Function

One major benefit of the CAT5 Whole-House Intercom System is that many different components can be integrated with it. The system below integrates Page Out feature of the P-0930 with the local audio input on the P-1014 1x4 CAT5 Audio Distribution Module. When a page is sent from the P-0930 it will interrupt the main audio source feeding the P-1014 so the page will be heard through the audio system's speakers. This is a great way to make pages audible in areas where there is no ST-2000 intercom station.

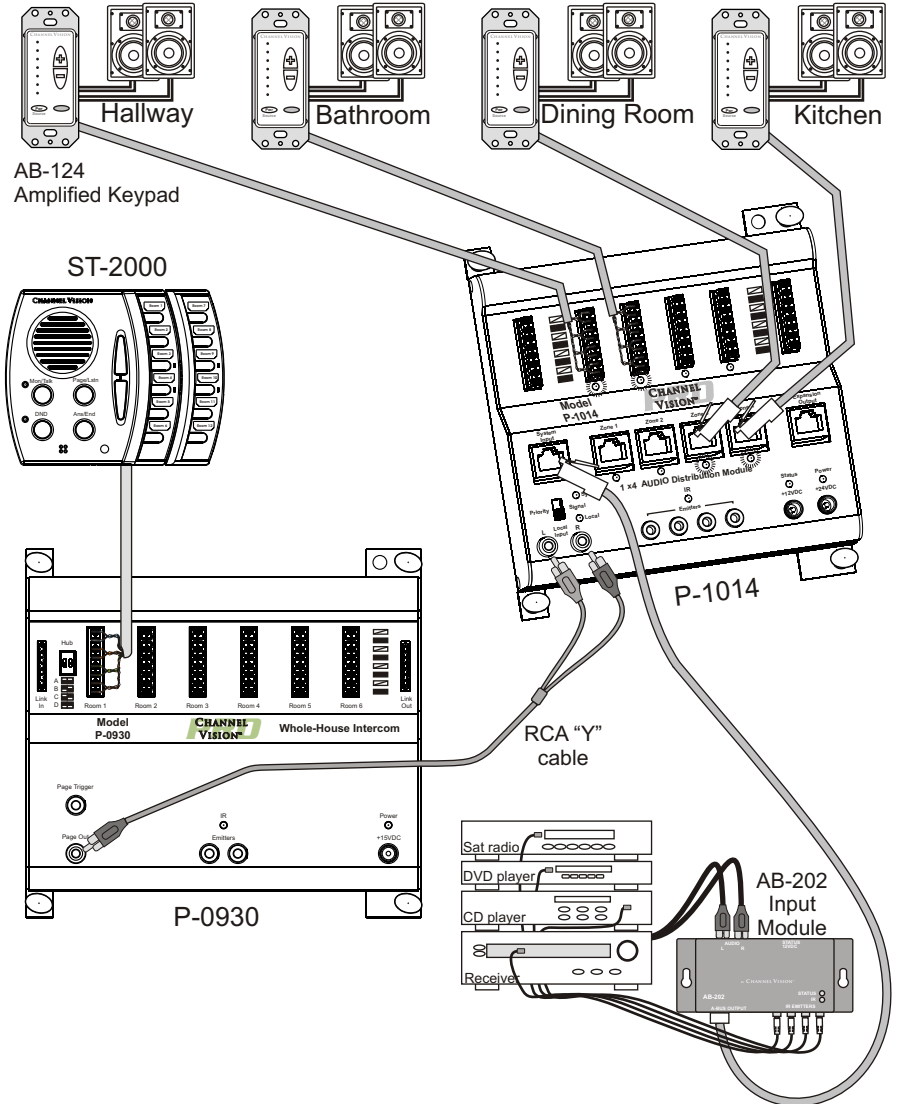

Connection Tips and Troubleshooting

- 1) Be sure you have connected the CAT5 cable correctly. Follow the color code indicated on the 110 connectors and use the TIA-568A color standard on any RJ-45 connectors in the system. Mis-wiring will prevent the system from working!
- 2) Having trouble calling from room to room?
 - A. Look at the status LEDs on the ST-2000. Do they function as indicated in the chart below?

ST-2000 LED Status Indicators		
DND LED color	Mon/Talk LED color	Meaning
-	-	Off/Standby
Red	-	DND
Green	-	On a call
Orange	-	Ring-only DND
-	Red	Room being Monitored
-	Green	Monitor Out/Page/Tone
	Orange(Green)	Push-To-Talk mode (Door to Room)

- B. Look at the IR LED on the P-0930 while pressing one of the call buttons on the ST-2000. It should flash when buttons are pressed. Now go to the room you are trying to call and repeat the test on that ST-2000. If the LED flashes both times, then IR control signals are being transferred from the intercom stations to the hub.
- 3) Trouble with IR control?
 - a. If you're having trouble controlling the system with the A0503 remote, make sure you have fresh batteries installed. Make sure you can control the system by pressing the buttons on the ST-2000. See troubleshooting step 2b.
 - b. If you're having trouble operating an IR controlled device when using the intercom's IR repeating system, check the IR LED on the P-0930 to make sure it flashes when the IR signals are detected by the ST-2000. Double check the IR emitter to ensure that it is located directly over the IR sensor of the device. Does the IR repeating system control some devices but not others? Check the IR specifications in the manual to make sure your device is compatible with this IR repeating system.
- 4) If the system is not responding, press and hold the DND button for 5 seconds. This will cause it to reboot.
- 5) If you need additional help troubleshooting this intercom system please contact Channel Vision technical support or check our website for more details: www.channelvision.com.

Stripping and Connecting CAT5 Wire

CAT5 cable should be stripped with a proper stripping tool, such as Channel Vision's J-110 tool.

1. Place the CAT5 between the blade and the first notch of the J-110 tool.

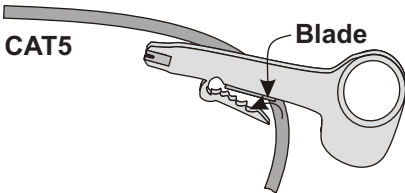

2. Rotate the tool only once. Multiple turns will cause you to cut into the inner wires.

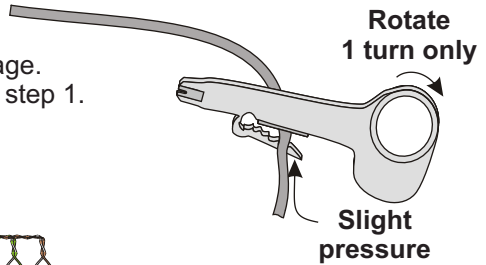

3. Inspect the inner wires for damage. If any wires are cut start over at step 1.



TIA-568A RJ-45 Modular Plug

Side view:

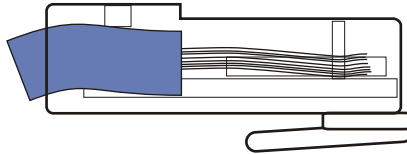

Top view:

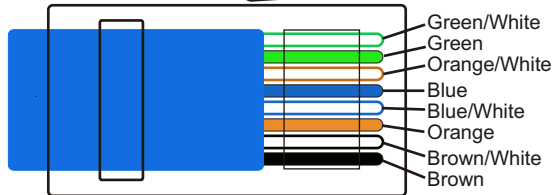

Specifications: (typical @25° C)

Operating Voltage :

15VDC

Cable Requirements:

4 pair UTP (CAT3 or better)

Recommended Max. Cable Length:

Door Station:

500ft

Wall Station:

350ft

IR Freq. range supported (ST-2000):

30 kHz - 60 kHz

IR pickup range (ST-2000):

40 ft. @ 38kHz, 25 ft. @ 56kHz

Operating Temperature:

-10°C to +50°C

Specifications subject to change without notice.



2 Year Limited Warranty

Channel Vision Technology will repair or replace any defect in material or workmanship which occurs during normal use of this product with new or rebuilt parts, free of charge in the USA, for two years from the date of original purchase. This is a no hassle warranty with no mail in warranty card needed. This warranty does not cover damages in shipment, failures caused by other products not supplied by Channel Vision Technology, or failures due to accident, misuse, abuse, or alteration of the equipment. This warranty is extended only to the original purchaser, and a purchase receipt, invoice, or other proof of original purchase date will be required before warranty repairs are provided.

Mail in service can be obtained during the warranty period by calling (800) 840-0288 toll free. A Return Authorization number must be obtained in advance and can be marked on the outside of the shipping carton.

This warranty gives you specific legal rights and you may have other rights (which vary from state to state). If a problem with this product develops during or after the warranty period, please contact Channel Vision Technology, your dealer or any factory-authorized service center.



234 Fischer Avenue, Costa Mesa, California 92626 USA
(714)424-6500 • (800)840-0288 • (714)424-6510 fax
email: techsupport@channelvision.com