

## CHANNEL VISION Limited Warranty

Channel Vision Technology will repair or replace any defect in material or workmanship which occurs during normal use of this product with new or rebuilt parts, free of charge in the USA, for two years from the date of original purchase. This is a no hassle warranty with no mail in warranty card needed. This warranty does not cover damages in shipment, failures caused by other products not supplied by Channel Vision Technology, or failures due to accident, misuse, abuse, or alteration of the equipment. This warranty is extended only to the original purchaser, and a purchase receipt, invoice, or other proof of original purchase date will be required before warranty repairs are provided.

Mail in service can be obtained during the warranty period by calling (800) 840-0288 toll free. A Return Authorization number must be obtained in advance and can be marked on the outside of the shipping carton.

This warranty gives you specific legal rights and you may have other rights (which vary from state to state). If a problem with this product develops during or after the warranty period, please contact Channel Vision Technology, your dealer or any factory-authorized service center.

# A0127W & A0127IA

## Keypad (for use with the A4601)

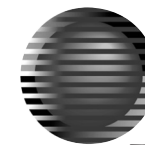
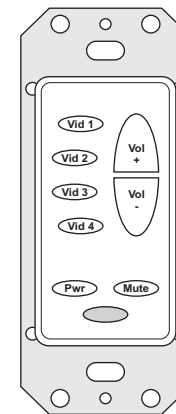

# CHANNEL VISION™

234 Fischer Avenue · Costa Mesa, CA 92626  
(714) 424-6500 · (800) 840-0288 · (714) 424-6510 fax  
www.channelvision.com · email: sales @ channelvision.com

# A0127 Keypad

**A0127 ... Keypad controller for use with the A4601.**

**Features:**

Available in both white (A0127W) and ivory/almond (A0127IA) colors.

Teaching capability allows controls to be stored in learning remote controls.

User changeable source buttons make it easy to customize.

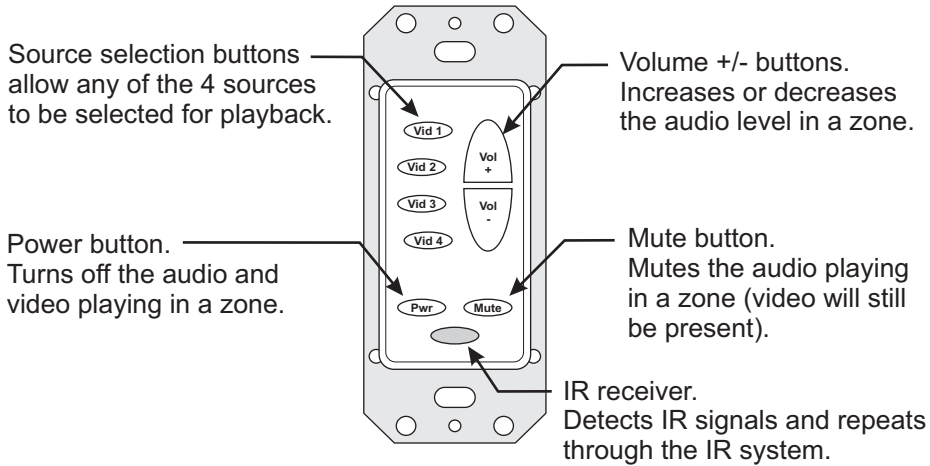

## How IR repeating works

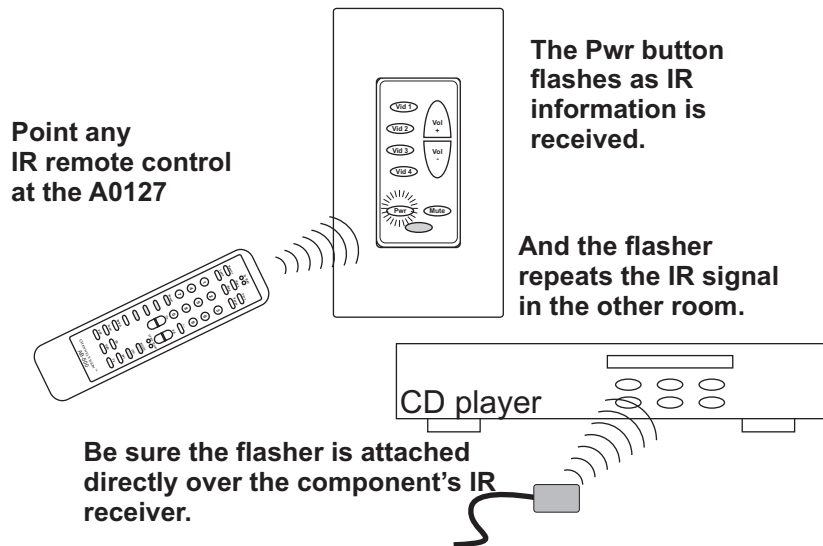

**Using the A0501 remote control..** designed to control your A4601.  
(Download IR codes at: [www.channelvision.com](http://www.channelvision.com) and [www.remotecentral.com](http://www.remotecentral.com))

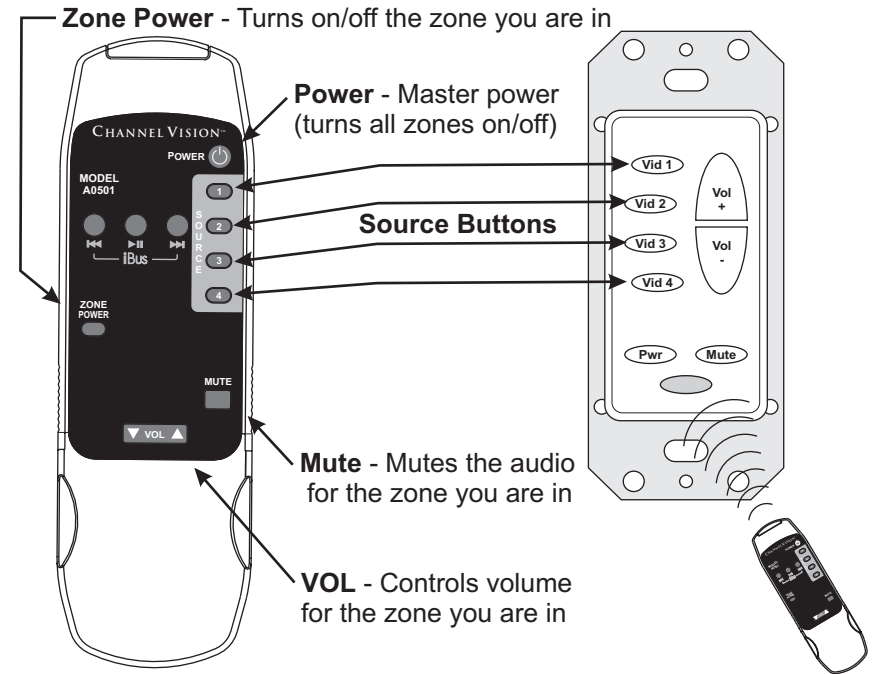

## Setting the A0127 as the master keypad...

By changing a jumper setting on the A0127 you can make it a master keypad. This simply means that the master A0127 will be able to power on or power off the entire system from a single zone.

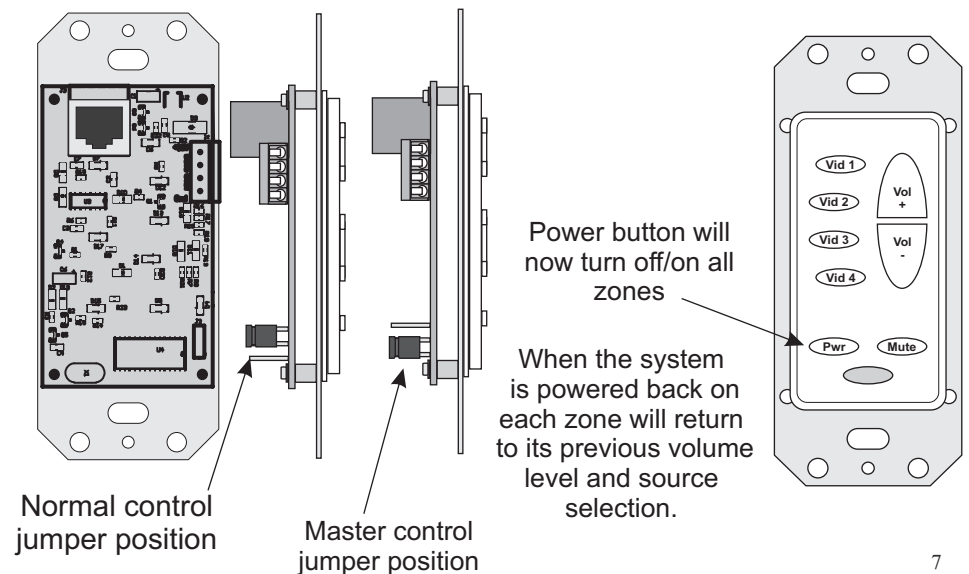

### Wiring the A0127 keypad...

Keypads connect to the A4601 through the RJ45 jacks on the back panel of the A4601. Connections to the A0127 may be accomplished either by using the RJ45 jack or the screw terminals provided on the back side of the keypad. When using the RJ45 jacks, simply wire both ends of the cable according to the TIA568A standard. When using the screw terminals on the A0127, make sure to wire the RJ45 plug connecting to the A4601 as shown below.

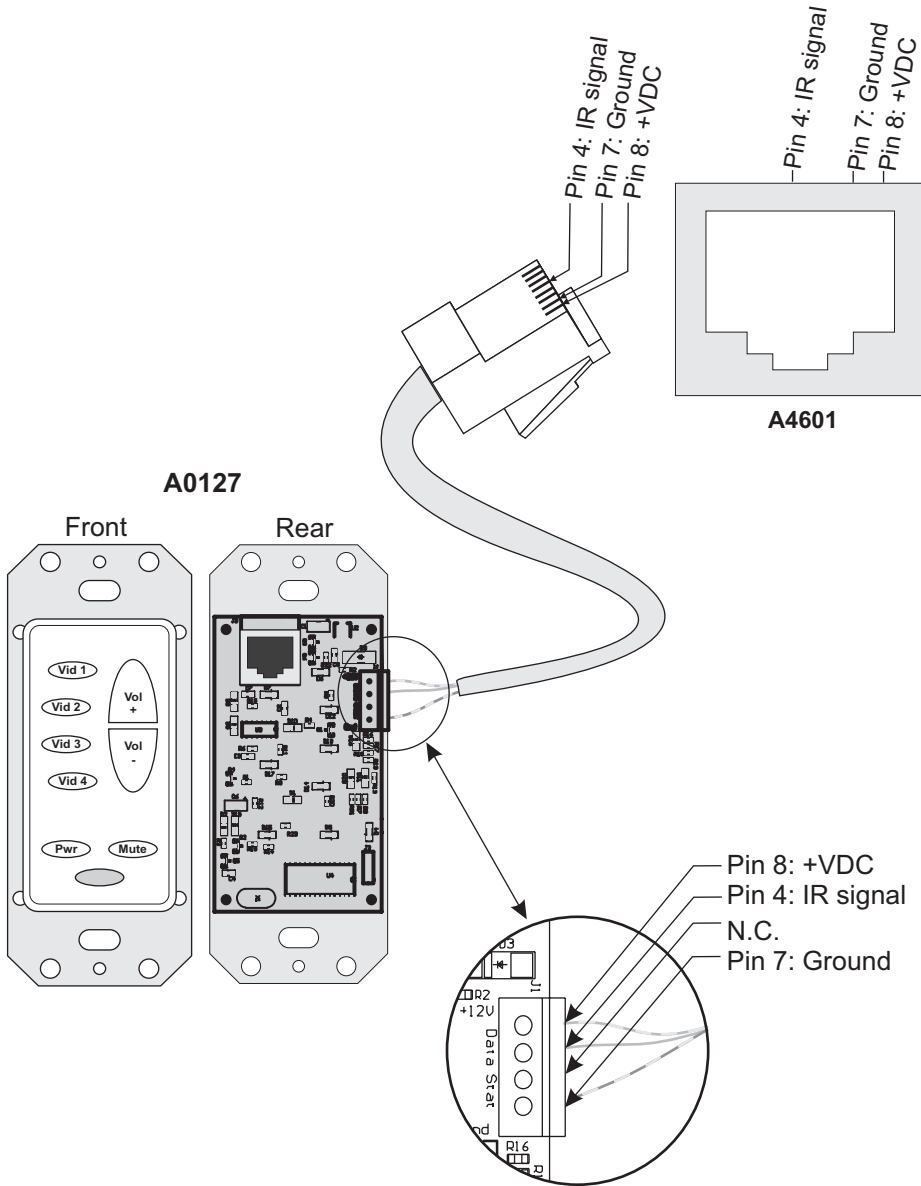

### Changing buttons face plates on the A0127 keypad...

The A0127IA comes with both Almond and Ivory face plates and buttons. Both the A0127W and A0127IA come with replacement buttons labeled for a variety of sources.

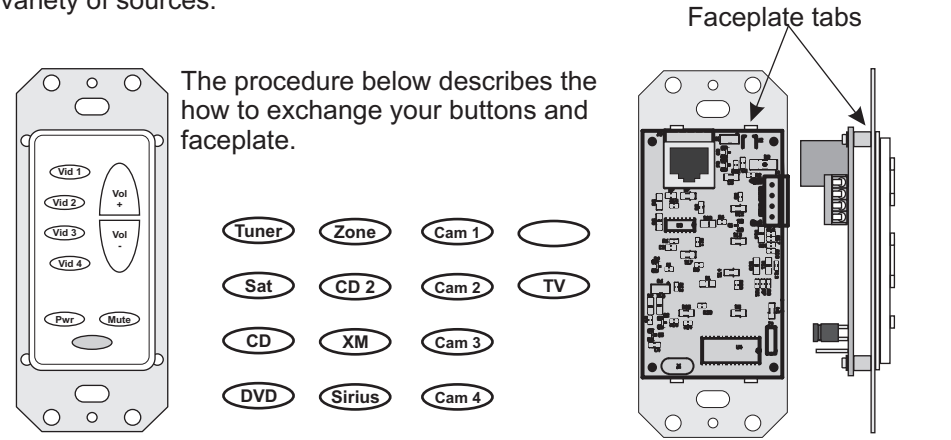

The procedure below describes the how to exchange your buttons and faceplate.

1 Detach the existing faceplate by pressing the plastic tabs with a flat blade screwdriver. (Press inward and upward ① at a 30 degree angle)

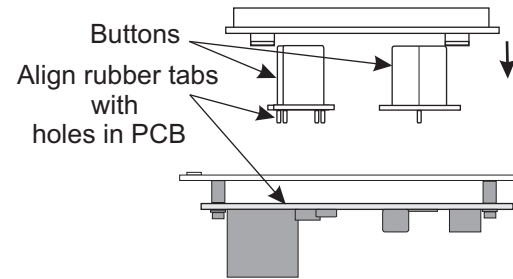

2 Exchange the labeled buttons (and colored faceplate) to your preference and assemble as shown

### Accessories

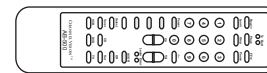

**AB-500** ... Universal remote control.. Learns IR codes for up to 6 sources.



**IR-3003 & IR-3002** ... Single and dual head IR flashers. Use one head per source to control from the remote room. (IR-3002 shown).

See page 6 for connection details

## A4601 Rear Panel

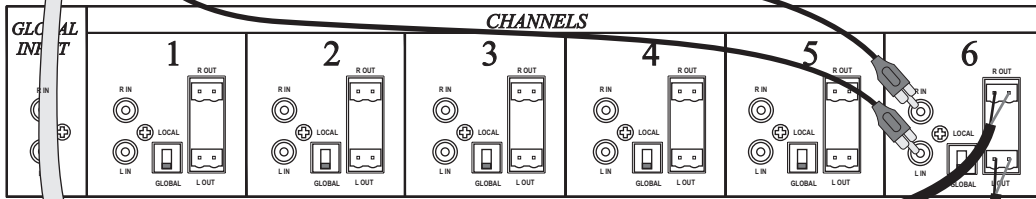
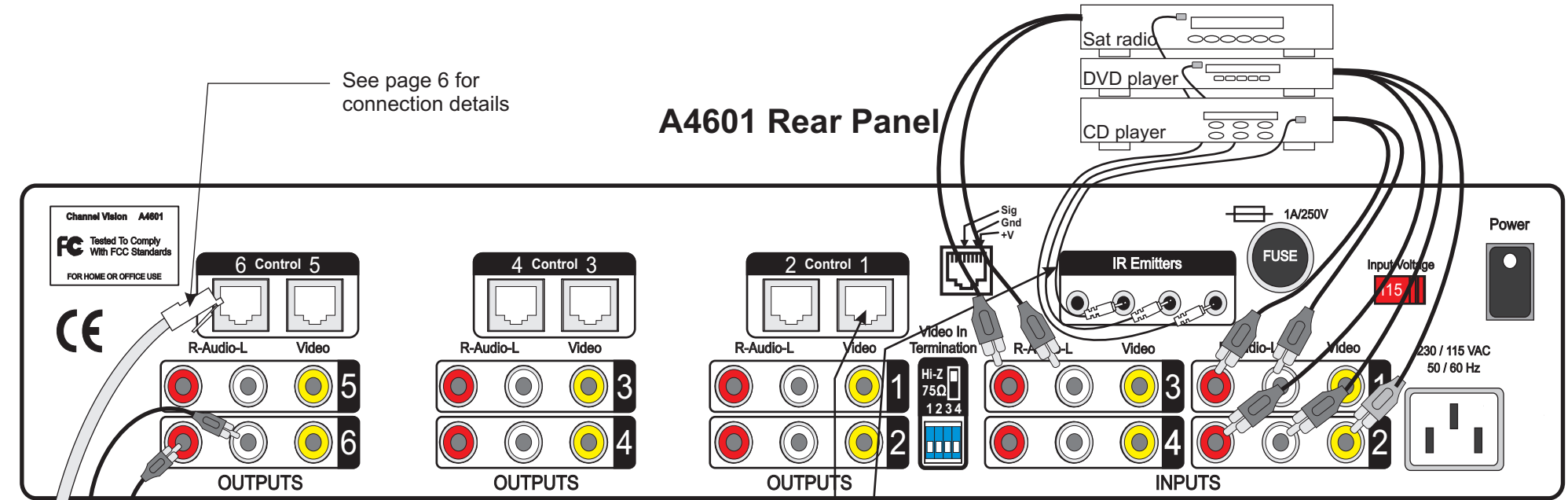

## A1260 Rear Panel

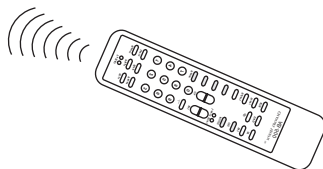
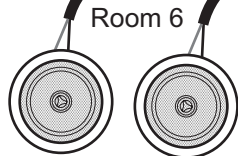
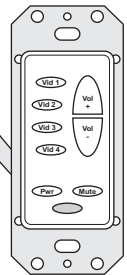

- IR emitter outputs allow IR-3002 flashers to be connected for remote control of source components.
- Each zone is controlled through the A0127 keypad which connects to the RJ45 jacks on the rear panel.
- A learning remote (such as the AB-500) can be programmed to control your source components and the A0127 (see page 7 for details). This is an easy way to control all your components from any room in the house.

Note: If you are using a Philips Pronto remote control, you may download IR codes for the A0127 from [www.channelvision.com](http://www.channelvision.com) or from [www.remotecentral.com](http://www.remotecentral.com).